

The concept of matrix-mediated coupling: a new interpretation of mixed-cation effects in glass

This article has been downloaded from IOPscience. Please scroll down to see the full text article.

2003 J. Phys.: Condens. Matter 15 S1595

(<http://iopscience.iop.org/0953-8984/15/16/309>)

View [the table of contents for this issue](#), or go to the [journal homepage](#) for more

Download details:

IP Address: 171.66.16.119

The article was downloaded on 19/05/2010 at 08:45

Please note that [terms and conditions apply](#).

# The concept of matrix-mediated coupling: a new interpretation of mixed-cation effects in glass

Malcolm D Ingram<sup>1</sup> and Bernhard Roling<sup>2</sup>

<sup>1</sup> Department of Chemistry, University of Aberdeen, Aberdeen AB24 3UE, UK

<sup>2</sup> Institut für Physikalische Chemie, Westfälische Universität, Münster, Germany

E-mail: m.d.ingram@abdn.ac.uk and roling@uni-muenster.de

Received 31 October 2002

Published 14 April 2003

Online at [stacks.iop.org/JPhysCM/15/S1595](http://stacks.iop.org/JPhysCM/15/S1595)

## Abstract

The concept of matrix-mediated coupling assumes that coupling between movements of unlike cations in glass occurs in order to dissipate mechanical stresses created by small cations entering sites which are too large (e.g. Li<sup>+</sup> ions entering empty sodium,  $\overline{\text{Na}}$ , sites) and large cations entering sites which are too small (e.g. Na<sup>+</sup> ions entering empty lithium,  $\overline{\text{Li}}$ , sites). A central feature of the mixed-alkali effect is therefore the intervention of structural interactions that minimize these stresses; these processes are essentially isochoric in nature. This concept helps in the understanding of several important phenomena in addition to the high pressure effects discussed previously, including the growth/suppression effects observed in mechanical loss spectra; the strong effect of foreign cations on the conductivity in the dilute foreign alkali region; the role of divalent cations in glass and the ‘anomalous’ behaviour of ion-exchanged glasses.

## 1. Introduction

The mixed-alkali effect (MAE) is one of the long standing puzzles of glass science [1–3], and it continues to attract detailed attention. In addition to conductivity and diffusivity anomalies, which are also found in crystalline beta-aluminas [4], in hydrated silicate glasses [5] and in molten salt hydrates [6], there is a family of effects occurring in glasses, which includes minima in melt viscosities and large mechanical relaxations found below the glass transition temperature [1–3], whose origins are poorly understood.

Within the past decade, several approaches to understanding these phenomena have been made based either on theoretical techniques involving molecular orbital [7], molecular dynamics [8–11] and Monte Carlo [12] calculations or on new structural information obtained by infrared and Raman [13, 14], EXAFS [15, 16] and NMR [17, 18] spectroscopies or neutron scattering experiments [14].

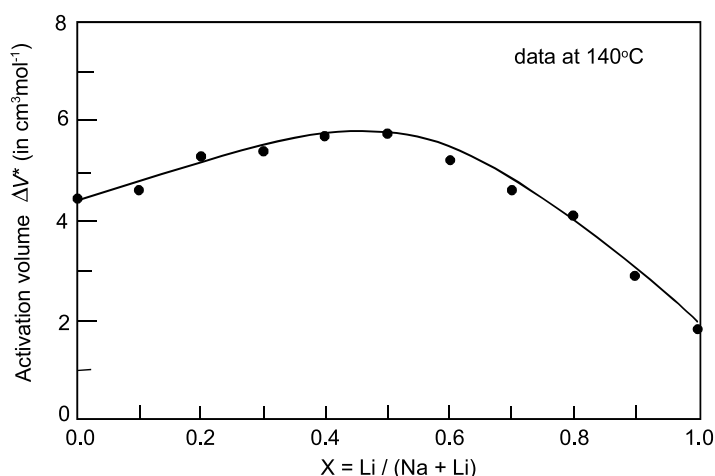

**Figure 1.** Variation in activation volume in mixed  $x\text{LiPO}_3 \cdot (1-x)\text{NaPO}_3$  glasses, for conductivities measured at  $140^\circ\text{C}$ . Data are from [17].

Although there is now some agreement following the work of Bunde *et al* [12] that site selectivity effects are important (e.g.  $\text{Li}^+$  ions will recognize empty lithium,  $\overline{\text{Li}}$ , sites and move into them faster than they would into empty sodium,  $\overline{\text{Na}}$ , sites) (however see also [19] for a different viewpoint), there are important issues waiting to be resolved. Thus, according to reference [12], a site relaxation occurs whenever  $\text{Li}^+$  ions enter  $\overline{\text{Na}}$  sites or vice versa. However, other authors [11, 14–16] suggest that ions will always seek out matching sites (by jumping further to reach them, if necessary). Maass [20] argues also that the concept of site relaxation occurring below the glass transition temperature,  $T_g$ , is not essential for explaining the MAE. These differences in viewpoint reflect differing ideas about the strength of the ion–network interaction and about the timescales on which cation induced relaxations can occur.

Very recently a new approach to ion–matrix interactions was proposed based on an interpretation of the effects of pressure on ionic conductivity in mixed-cation glasses [21]. The system investigated was a set of  $x\text{LiPO}_3 \cdot (1-x)\text{NaPO}_3$  glasses ( $0 \leq x \leq 1$ ), which had previously [22, 23] been shown to exhibit ‘typical’ mixed-cation effects, including minima in conductivities and  $T_g$ s. From high pressure measurements, it was possible to determine activation volumes from the equation

$$\Delta V^* = -RT \, d \ln \sigma / dP \quad (1)$$

where  $P$  is the equilibrium pressure (in Pa).

Figure 1 shows how  $\Delta V^*$  varied across the composition range (data are for  $140^\circ\text{C}$  [21]). The remarkable result is that  $\Delta V^*$  increases *both* when  $\text{Li}^+$  ions in the  $\text{LiPO}_3$  glass are replaced by  $\text{Na}^+$  ions *and* when  $\text{Na}^+$  ions in the  $\text{NaPO}_3$  glass are replaced by  $\text{Li}^+$  ions. In one sense this result was not surprising. Thus, in another (incomplete) mixed-cation system [24] trends in activation energy were paralleled by changes in  $\Delta V^*$ . Moreover, the result is partly consistent with a recent approach [19] for explaining the MAE, where larger cations (here it would be the  $\text{Na}^+$  ions) expand and smaller cations (here it would be the  $\text{Li}^+$  ions) shrink the overall glass network structure. Following such an approach, the replacement of  $\text{Na}^+$  ions by  $\text{Li}^+$  ions (which occurs on the left-hand side of figure 1) would lead to network shrinkage, and so the  $\text{Na}^+$  ions would require a *larger* volume of activation, as indeed is the case. However, it is less easy to explain the even greater increase in activation volume observed when  $\text{Li}^+$  ions are replaced by  $\text{Na}^+$  ions, since this substitution leads to network expansion.

It was also noticed that a very simple rule was being obeyed where  $\Delta V^*(\max) \cong \Delta V^*(x = 0) + \Delta V^*(x = 1)$ . Thus the activation volumes were not the average, but rather the *arithmetic sum* of those pertaining to the single-cation glasses. To explain this rather striking, but possibly coincidental result, it was proposed [21] that  $\text{Li}^+$  and  $\text{Na}^+$  ion motions were strongly coupled to each other, and that this coupled motion had become the dominant process in these mixed cation glasses.

The purpose of the present paper is to examine more closely this new ‘concept of matrix-mediated coupling’ (CMMC), and to determine its wider relevance to ion transport processes in glassy materials. The effect of pressure, as such, is not further discussed.

## 2. The concept of matrix-mediated coupling (CMMC)

### 2.1. Background to the concept

The starting point is the dynamic structure model of Bunde *et al* [12]. There it was assumed that the mobile cations help shape the glass structure even as they move around.  $\overline{\text{Na}}$  sites would therefore exist close to  $\text{Na}^+$  ions and  $\overline{\text{Li}}$  sites would be found close to  $\text{Li}^+$  ions, and it was convenient to consider that these  $\overline{\text{Na}}$  and  $\overline{\text{Li}}$  sites existed by virtue of a ‘memory effect’. The empty  $\overline{\text{Na}}$  and  $\overline{\text{Li}}$  sites became the ‘stepping stones’ which formed the pathways for the migration of each cation in both single- and mixed-cation glasses.

In effect, ions in glass were expected to jump into nearby sites and for preference into matching sites. Where a mismatch occurred, e.g. when a  $\text{Na}^+$  ion attempted to move into a  $\overline{\text{Li}}$  site, such a process would be less likely to happen, and would be accompanied by a *site relaxation* process. The nature of the site relaxation was not explored in any detail, however, and subsequently Maass [20] expressed the view that these processes would be more likely to occur in the supercooled liquid rather than in the glassy state.

The CMMC is based on the dynamic structure model, but it differs in approach by drawing attention to what happens when cations do move into the ‘wrong’ sites.

### 2.2. The simplified model

Figure 2 shows how such ‘wrong’ ionic hops may be envisaged. In many respects, the picture resembles Martin’s visualization [25] of the classical Anderson–Stuart model. However, it also shows how tensile and compressive stresses are created at the ‘target site’ in mixed-cation glasses when incoming cations find sites that are either too large or too small for them. By raising the energies of ions in these sites, these stresses would contribute significantly to the mismatch energies described in the dynamic structure model [12].

We now consider that these mismatch energies can be dissipated in several ways. First, the ion can move back into its original site. This is in effect the ‘single-particle relaxation pathway’ of Funke’s concept of mismatch and relaxation [26], which typically is applied to single-cation systems. The result is that the stresses immediately disappear, but the ion must now seek a different pathway through the glass.

Second, the immediate environment of the target site can relax as indicated by the arrows in figure 2. When, for example,  $\text{Li}^+$  ions arrive at  $\overline{\text{Na}}$  sites, as in (a), there is a tensile stress created which is absorbed by the surrounding matrix. This stress relaxation changes the surrounding energy landscape and modifies the sites occupied by cations in this region of the glass, the effect being greatest in the immediate vicinity of the ‘foreign’ cation. A corresponding, but opposite, effect occurs when  $\text{Na}^+$  ions enter  $\overline{\text{Li}}$  sites. These processes should both modify the glass structure. Indeed, there is experimental evidence from both infrared and NMR

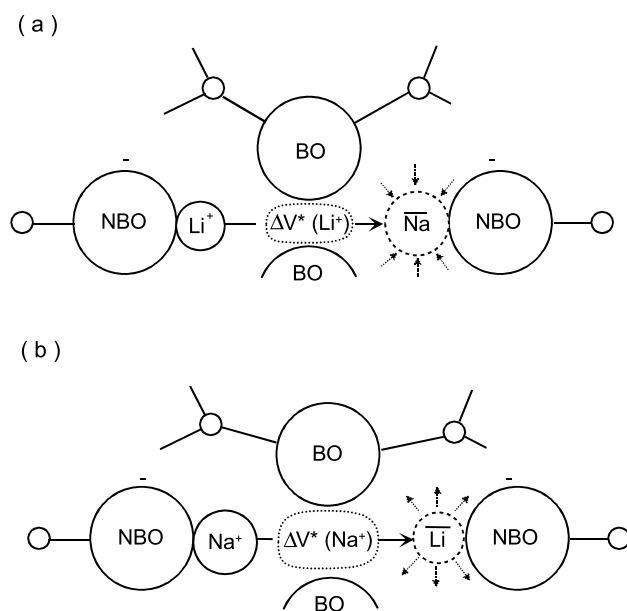

**Figure 2.** Schematic representation of ion hopping processes in mixed-cation glasses, based on [20]: (a)  $Li^+$  ions hopping into  $\overline{Na}$  sites, and (b)  $Na^+$  ions hopping into  $\overline{Li}$  sites.

spectroscopies [27, 28] that ‘larger’ cation sites expand and ‘smaller’ cation sites contract in mixed-cation glasses.

Finally, one can envisage the situation which arises if the hopping (and relaxation) processes illustrated in figure 2 occur near enough to become strongly coupled to each other. Under favourable conditions, the associated expansions and contractions will be self-cancelling, and so the overall process will occur at constant volume, i.e. it will be essentially *isochoric* in nature. We now propose that this direct coupling of cation hopping processes (which it was argued previously led to the summation of activation volumes [21]) could become the dominant process in mixed-cation glasses of high total alkali content, especially as the glass is heated towards  $T_g$  and localized network relaxations are permitted.

### 3. Applications of CMMC to behaviour in mixed-cation glasses

#### 3.1. Internal friction peaks

Figure 3 shows mechanical loss spectra, given here as plots of  $\tan \delta$  versus temperature  $T$  (in  $^{\circ}C$ ), obtained at constant frequency (0.4 Hz) for small replacements of  $Li_2O$  by  $Na_2O$  in  $Li_2O \cdot 3SiO_2$  glasses, as reported by Shelby and Day [29]. The spectra reveal characteristic ‘internal friction’ peaks arising from the motions of the ‘fast’  $Li^+$  ions (this is the peak appearing below  $0^{\circ}C$ ), and ‘slower’  $Na^+$  ions (this is the higher temperature peak appearing around  $100^{\circ}C$ ). The beginnings of the glass transition also appear as huge rises in mechanical loss at temperatures approaching  $400^{\circ}C$ .

A generally accepted viewpoint, see for example [29] and [30], is that mechanical loss peaks in glass arise quite simply from the coupling of external stress fields to ion hopping processes. In some way, the external stresses modify the potential energy landscape to favour ion hopping in some preferred direction. In single-cation glasses, this hopping rate

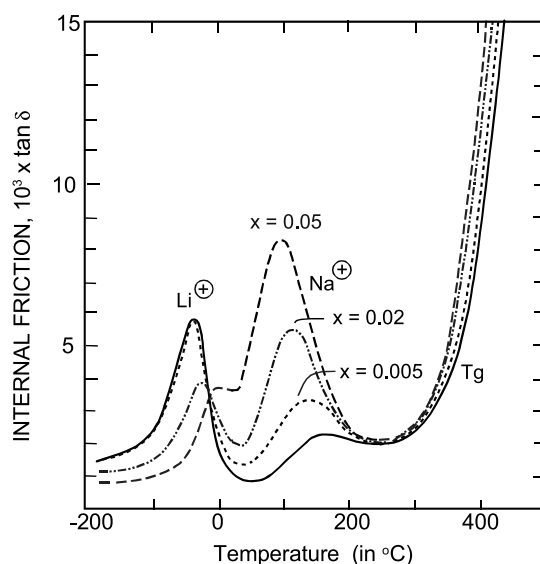

**Figure 3.** Internal friction peaks obtained for  $x\text{Na}_2\text{O} \cdot (1-x)\text{Li}_2\text{O} \cdot 3\text{SiO}_2$  glasses over a range of temperatures at a constant frequency of 0.4 Hz. Data are from Shelby and Day [25].

can be obtained either from the position of the internal friction peak, or alternatively from the ‘crossover frequency’ for the change from dc to dispersive behaviour as obtained by ac impedance spectroscopy [30, 31].

The behaviour shown in figure 3 is typical of mixed-cation glasses, and is notable in three respects. First, the higher temperature ( $\text{Na}^+$  ion or mixed-cation) peak is relatively intense. Thus, replacement of just 2% of the original  $\text{Li}^+$  ions by  $\text{Na}^+$  ions results in a loss peak similar in size to the  $\text{Li}^+$ -ion peak originally found in the all-lithium glass. Second, the growth of this  $\text{Na}^+$  ion peak is accompanied by a corresponding shrinkage of the  $\text{Li}^+$ -ion peak. This ‘suppression effect’ is also found in mixed alkali–alkaline-earth glasses [30, 31], and has never been adequately explained. Third, the replacement of  $\text{Li}^+$  by  $\text{Na}^+$  leads to a progressive lowering of the glass transition temperature.

We shall argue that all these phenomena are a logical outcome of the matrix-mediated cation coupling processes. Thus, the ‘pairwise’ movements of unlike ions create mechanical dipoles that can respond either to shear or bending stresses being applied *externally* (hence the relatively large mixed cation peaks). Since these ‘dipoles’ continually form and disappear as a result of thermal motions, there are always large *internal* stress fields present in mixed-cation glasses. It is the response of the glassy matrix to these internal stresses which makes mixed-cation glasses behave differently from single-cation systems.

Since the majority  $\text{Li}^+$  ions move about more rapidly than the mixed-cation dipoles can relax, one can regard the stresses created by the dipoles which they experience as being essentially *static* in nature. This results in an apparently ‘permanent’ distortion of the energy landscape, which prevents externally applied stresses from coupling with ion hopping processes. This also explains the suppression effect which is exemplified in figure 3. The loss in mechanical compliance associated with the ‘lost’  $\text{Li}^+$ -ion motions is indeed analogous to dielectric saturation occurring within the hydration sheaths of cations in aqueous systems [32].

On the other hand, the mixed-cation dipoles are being created, and are rotating or reappearing much faster than the overall structure relaxes. We argue here that this continuous

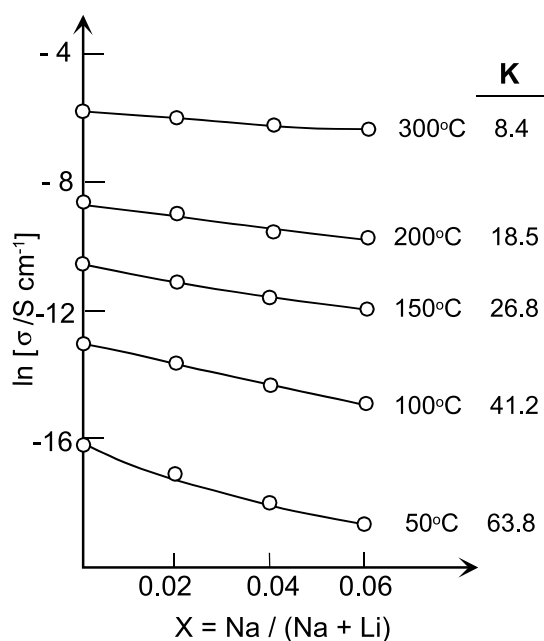

**Figure 4.** ‘Limiting’ dilute foreign alkali behaviour in 0.55 Li<sub>2</sub>O-0.45 P<sub>2</sub>O<sub>5</sub> glasses (Li<sup>+</sup> being replaced by Na<sup>+</sup>), at different temperatures [31], where  $K = -d \ln \sigma / dX$  as  $X \rightarrow 0$ , and  $X$  is the fraction of Li<sup>+</sup> replaced by Na<sup>+</sup>.

mechanical activity weakens the glass structure. The synergetic repositioning of mixed-cation dipoles facilitates network rearrangements and thus ‘catalyses’ the onset of viscous flow. The lowering of the glass transition temperature is a consequence of this second coupling process.

Further inspection of figure 3 shows that the Li<sup>+</sup> ion peak is moving to higher temperatures with increasing Na<sup>+</sup> ion concentration. It is clear therefore that the suppression effect mentioned above is associated with a strong decrease in the mobility of the host cations. This effect is discussed in more detail in the following section.

### 3.2. The dilute foreign alkali region

Moynihan *et al* [33, 34] reported steep decreases in conductivity in  $1 - x\text{K}_2\text{O} \cdot (x)\text{Na}_2\text{O} \cdot 3\text{SiO}_2$  glasses, in the ‘dilute foreign alkali’ region, i.e. as  $x \rightarrow 0$ . Those authors remarked that these results are especially interesting in the limit as  $x \rightarrow 0$ , since under these conditions all the current is carried by K<sup>+</sup> ions. There are, therefore, no complications arising from mixed-ion conductivity, and the resulting pattern of behaviour should be very informative concerning mechanisms of ion transport.

Their experimental results indicated that each Na<sup>+</sup> ion introduced into the K-based glass seemed able to immobilize large numbers of the host cations. Ingram *et al* [35, 36] extended these investigations to include a much wider range of glasses, initially with the intention of gaining data supporting the weak electrolyte theory of glass. Some of these data are shown in figures 4 and 5.

Figure 4 shows how the conductivity of a 0.55 Li<sub>2</sub>O-0.45 P<sub>2</sub>O<sub>5</sub> glass decreases as an increasing fraction of Li<sup>+</sup> is replaced by Na<sup>+</sup>. The strength of this effect can be expressed as a ‘vulnerability parameter’  $K = -d \ln \sigma / dX$ , as  $X \rightarrow 0$ . Effectively,  $K$  indicates the

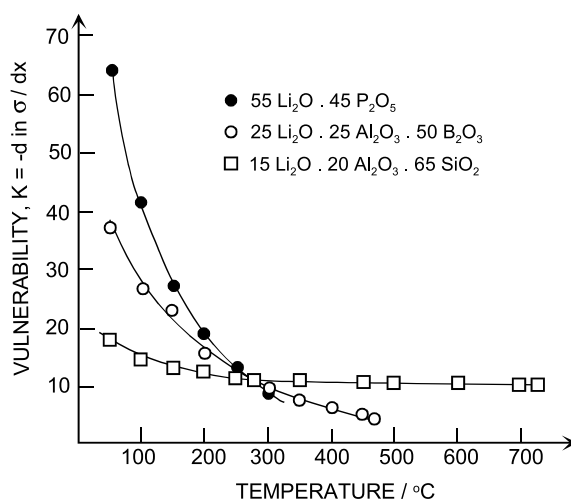

Figure 5. Temperature-dependent 'vulnerabilities',  $K$ , see figure 4, for several glasses [31].

fraction of the conductivity which disappears for each fraction of the total lithium replaced. The  $K$ -values are always greater than unity, but decrease with increasing temperature. The fact that the MAE is so strong even at infinite dilution (i.e. as the *foreign* cation concentration goes to zero) indicates (unless e.g. a weak electrolyte approach is adopted) that *long range interactions* involving the foreign cations are involved.

Figure 5 shows how  $K$  varies with temperature for several glasses (the data at higher temperatures for the aluminosilicate glasses being obtained by extrapolation of appropriate Arrhenius plots). The behaviour of the lithium phosphate and of the lithium aluminoborate glasses is typical of many alkali-cation glasses.  $K$  falls sharply from high values (i.e.  $>50$ ) at ambient temperature to less than ten in the vicinity of  $T_g$ . The implication is that as the glass gets hotter, the long range interactions disappear and more and more become dissipated within the immediate environment of the foreign cations. This is entirely consistent with CMMC since the long range *interaction* depends on the storage and transmission of stress within the network structure, which inevitably is weakened as the glass transition approaches.

The situation in aluminosilicate glasses is rather different. The amount of coupling seen even at low temperatures is small (probably because there is a much smaller total alkali content), but it also varies much less with temperature (probably because the network is strong even at  $T_g$ ). One expects that these 'glasses' will show an MAE which persists even further above  $T_g$  than is the case for binary alkali silicate melts, see e.g. [37].

### 3.3. Ion-exchanged glasses

Ion exchange is an important process used in preparing chemically strengthened glass [38, 39]. Normal 'float' glass (a multi-component 'soda-lime-silica' glass, with  $T_g \approx 550^\circ\text{C}$ ) is typically strengthened by immersion in molten  $\text{KNO}_3$  at  $460^\circ\text{C}$  for several hours. Following ion exchange, where the reaction is

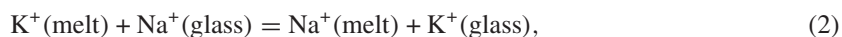

a mixed-cation interdiffusion layer is built up, some tens of microns deep. The strengthening arises from compressive stresses generated in the glass surface as  $\text{K}^+$  ions will ideally replace  $\text{Na}^+$  ions under *isochoric* conditions [38, 39].



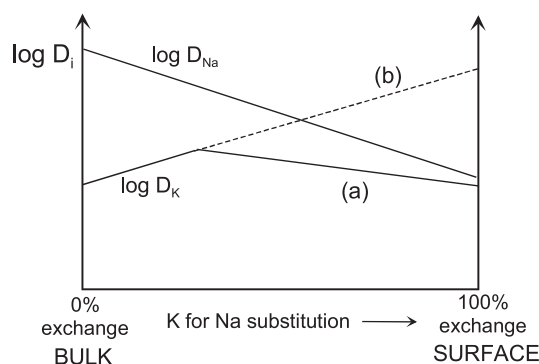

**Figure 6.** Schematic representation (a) of ‘anomalous’ variations in self-diffusion coefficients of  $\text{Na}^+$  and  $\text{K}^+$  in ion-exchanged float glass, showing the absence of a mobility crossover and a continuous decrease in conductivity (indicated by the mobility of the faster cation) as  $\text{Na}^+$  is replaced by  $\text{K}^+$  [33]. (b) The ‘normal’ behaviour which obtains in melt-grown glasses.

Tomandl and Schaeffer [40], and later Ingram *et al* [38], showed that under these conditions a ‘normal’ MAE is not obtained. The maximum in resistivity does not coincide, as expected, with a roughly 50:50 mixture of  $\text{Na}^+$  and  $\text{K}^+$  ions. Instead, the most resistive part of the inter-diffusion layer is the  $\text{K}^+$ -rich region in the surface which has been exposed to the molten salt.

This unexpected behaviour is represented schematically in figure 6, see also [38]. Figure 6 shows that the ‘anomaly’ arises because there is no crossover in mobilities. Over most, if not all, of the composition range,  $\text{K}^+$  ions migrate more slowly than do  $\text{Na}^+$  ions. As a result, the conductivity in the ion-exchanged layer is dominated by the faster  $\text{Na}^+$  ion, while the inter-diffusion of cations is very largely controlled by the slower  $\text{K}^+$  ion.

The sluggishness of  $\text{K}^+$  ion migration can be attributed to an absence of *empty*  $\bar{\text{K}}$  sites, due to the lack of volume. Therefore, if a  $\text{K}^+$  ion attempts to hop into an empty  $\bar{\text{Na}}$  site (should one still exist), this process cannot be assisted by a  $\text{Na}^+$  ion hopping into a vacant  $\bar{\text{K}}$  site. The normal MAE in fact occurs only in a glass containing a number of empty  $\bar{\text{Na}}$  and  $\bar{\text{K}}$  sites appropriate for the glass composition; the CMMC then comes into operation and both ions can move.

### 3.4. Glasses containing divalent cations

The introduction of divalent cations into glass considerably widens the scope of this discussion. For example, it opens up the opportunity of studying mixed-cation effects using cations of approximately the same size (e.g. in  $\text{Na}^+/\text{Ca}^{2+}$  systems). Roling and Ingram [30, 31] have applied dynamic mechanical thermal analysis (DMTA) to study mechanical loss peaks (equivalent to the internal friction peaks described in section 3.1) arising from the movement of  $\text{Mg}^{2+}$ ,  $\text{Ca}^{2+}$ ,  $\text{Sr}^{2+}$  and  $\text{Ba}^{2+}$  ions in  $\text{Na}_2\text{O}\cdot 2\text{MO}\cdot 4\text{SiO}_2$  glasses.

Figure 7 is a ‘relaxation map’ for hopping processes and structural relaxation ( $T_g$ ) in these mixed cation glasses. The hopping rates for the  $\text{Na}^+$  ions are determined by impedance spectroscopy because often they cannot be found in the mechanical spectrum owing to the suppression effect, which was discussed in section 3.1. The hopping of divalent cations is determined directly by mechanical spectroscopy.

In these glasses, the concentrations of sodium and divalent cations are always the same and always equal. Nevertheless, the sodium ions are always more mobile than their divalent

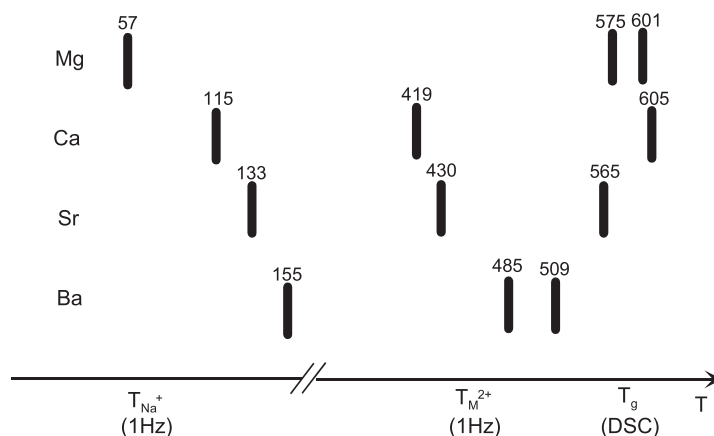

**Figure 7.** 'Relaxation map' for  $\text{Na}_2\text{O}\cdot 2\text{MO}\cdot 4\text{SiO}_2$  glasses.  $T_{\text{Na}^+} + (1 \text{ Hz})$  denotes the temperature where the onset frequency of the conductivity dispersion is 1 Hz [41]. (The conductivity dispersion is caused by the hopping motions of the  $\text{Na}^+$  ions.)  $T_{M^{2+}} + (1 \text{ Hz})$  denotes the peak temperature of the second mechanical loss peak at a measurement frequency of 1 Hz. This high temperature peak is closely related to hopping motions of the alkaline-earth ions.  $T_g(\text{DSC})$  is the glass transition temperature determined by DSC at a scan rate of  $10 \text{ K min}^{-1}$ . The separation of these processes on the temperature scale is a good indication of how far these processes are decoupled from each other [31, 41].

counterparts as is indicated by their much lower 'relaxation temperatures'. There is no tendency here for the low-temperature loss peak to be subsumed into the high temperature or mixed-cation peak, as is found in mixed alkali glasses. This difference in behaviour points up the much smaller intrinsic mobility of divalent as compared to univalent cations generally. It is also apparent that within this system, the  $\text{Ca}^{2+}$  ion is the most mobile of the divalent ions. The simplest explanation is that since  $\text{Na}$  sites are the right size for  $\text{Ca}^{2+}$  ions and vice versa (note that the ionic radii are  $r(\text{Ca}^{2+}) = 99 \text{ pm}$  and  $r(\text{Na}^+) = 95 \text{ pm}$ ) there is little in the way of mechanical stress generated when these cations change places. The movement of calcium ions, as compared with other divalent cations, incurs a minimum of network distortion. This lessening of network participation may also be signalled by the relatively high glass transition temperature in the soda-lime-silica glass system, and the remarkable decoupling of  $\text{Ca}^{2+}$  ion movements from the structural relaxations occurring at the glass transition [41] as indicated by the large 'temperature gap' between the peak temperature of the second mechanical loss peak,  $T_{M^{2+}}$ , and the glass transition temperature measured by differential scanning calorimetry, (DSC)  $T_g$ , shown in figure 7.

For a wider series of  $\text{A}_2\text{O}\cdot 2\text{MO}\cdot 4\text{SiO}_2$  glasses (where the alkali cation  $\text{A}^+$  can be varied), Martiny *et al* [42] found that when  $\text{A}^+ = \text{Li}^+$  and  $\text{M}^{2+}$  is  $\text{Mg}^{2+}$ , and when  $\text{A}^+ = \text{K}^+$  and  $\text{M}^{2+}$  is  $\text{Ba}^{2+}$ , each of these divalent cations becomes more mobile than  $\text{Ca}^{2+}$ . In all the mixed alkali-alkaline-earth glass systems, the identity of the 'fastest' of the  $\text{M}^{2+}$  cations is thus determined by its size. Chemical effects such as the preferences each cation may show for bridging or non-bridging oxygens do not seem to be important in this context.

#### 4. Conclusions

The CMMC has been applied qualitatively, and successfully, to describe a range of behaviours encountered in mixed-cation glasses, including mechanical loss spectra in mixed alkali and

in mixed alkali–alkaline-earth glasses, limiting conductivity dependences in the dilute foreign alkali region and ‘anomalous’ MAEs in ion-exchanged glass. CMMC emerges, therefore, as a robust hypothesis—despite it having been ‘called into existence’ to explain trends in activation volume seen in a single mixed-cation system. The basic concept is simple: namely that ion-transport-induced processes occurring in a rigid glass below  $T_g$  will tend to be isochoric in nature. As a corollary, it may also be suggested that if a process is isochoric, there is also a good chance that it may occur below  $T_g$ .

In a broader sense, the significance of this new concept is that it seems to cut across historically well established concepts of coupling [43] and decoupling [44, 45], which until now have provided the main framework for discussions of glassy ionics. It is commonplace to assume that mobile ions migrate without perturbing the network structure of a glass, but nevertheless can strongly influence each other. It is now proposed that the glass network participates in important *coupling* processes. The end result is that in mixed-cation glasses the structural dynamics are transformed in such a way as to influence a wide range of glass properties. Thus the minima in  $T_g$  referred to in the introduction and again in section 3.1 are just as clearly a manifestation of the MAE as are the better known changes in ion mobilities. Such minima in  $T_g$  have even been observed in mixed alkaline-earth systems [41], which suggests that the properties of these glasses close to  $T_g$  can be influenced by the presence of magnesium–calcium pairs acting as mechanical dipoles.

In summary, this approach to mixed-cation effects differs from that advanced by Moynihan [6] and by many others subsequently. Thus, Moynihan focused his attention on changes in ion mobility which, as indicated in the introduction, occur when cations are mixed in many materials, some of which are glass forming and some are not. The present focus is in one sense narrower, since it is directed mainly at network glasses. In another sense it is broader, since it encompasses a wider range of physical phenomena which often influence technological applications of multi-component glasses.

Further experiments are needed before CMMC can be turned into a ‘working theory’ of the MAE. The effects of pressure on ion transport, including tracer diffusion and ionic conductivity, demand further attention. Knowledge is needed of how activation volumes vary with composition in both single- and mixed-cation glasses. Ultimately, this should lead to a critical assessment of the new ideas involving CMMC, in the context of ongoing developments in this field [1–20], with a view to establishing a more comprehensive model for the MAE and for ion transport in glasses generally.

## Acknowledgments

The authors are indebted to C T Imrie (Aberdeen University, Scotland), H Jain (Lehigh University, USA), E I Kamitsos (NHRF, Athens), and to K Funke and H Eckert (University of Muenster, Germany) for discussions which helped shape the ideas advanced in this paper. One of us, MDI, wishes to thank the Alexander von Humboldt Foundation for a Research Award.

## References

- [1] Isard J O 1969 *J. Non-Cryst. Solids* **1** 235
- [2] Day D E 1976 *J. Non-Cryst. Solids* **21** 343
- [3] Ingram M D 1987 *Phys. Chem. Glasses* **28** 215
- [4] Bruce J A and Ingram M D 1986 *Solid State Ion.* **18/19** 1129
- [5] Garcia N J, Ingram M D and Bazan J C 2002 *Solid State Ion.* **146** 113
- [6] Moynihan C T 1979 *J. Electrochem. Soc.* **126** 2144
- [7] Uchino T, Sakka T, Ogata Y and Iwasaki M 1992 *J. Non-Cryst. Solids* **146** 26

- [8] Habasaki J, Okada I and Hiwatari Y 1995 *J. Non-Cryst. Solids* **183** 12
- [9] Balasubramanian S and Rao K J 1994 *J. Phys. Chem.* **98** 10871
- [10] Smith W, Forester T R, Greaves G N, Hayter S and Gillan M J 1997 *J. Mater. Chem.* **7** 331
- [11] Park B and Cormack A N 1999 *J. Non-Cryst. Solids* **255** 112
- [12] Bunde A, Ingram M D and Maass P 1994 *J. Non-Cryst. Solids* **172–174** 1222
- [13] Rau C, Armand P, Pradel A, Varsamis C P E, Kamitsos E I, Granier D, Ibanez A and Philippot E *Phys. Rev. B* **63** 184204
- [14] Swenson J, Matic A, Brodin A, Börjesson L and Howells W S 1998 *Phys. Rev. B* **58** 11332
- [15] Greaves G N, Catlow C R A, Vessal B, Charnock J, Henderson C M B, Zhu R, Qiao S, Wang Y, Gurman S J and Houde-Walter S 1990 *Inst. Phys. Conf. Ser.* **111** 411
- [16] Greaves G N and Ngai K L 1995 *Phys. Rev. B* **52** 6538
- [17] Florian P, Vermillion K E, Grandinetti P J, Farnan I and Stebbins J F 1996 *J. Am. Chem. Soc.* **118** 3493
- [18] Gee B and Eckert H 1996 *J. Phys. Chem.* **100** 3705
- [19] Kirchheim R 2000 *J. Non-Cryst. Solids* **272** 85
- [20] Maass P 1999 *J. Non-Cryst. Solids* **255** 35
- [21] Bandaranayake P W S K, Imrie C T and Ingram M D 2002 *Phys. Chem. Chem. Phys.* **4** 3209
- [22] Chen R, Yang R, Durand B, Pradel A and Ribes M 1992 *Solid State Ion.* **53–56** 1194
- [23] Shelby J E 2000 *J. Non-Cryst. Solids* **263/264** 271
- [24] Ingram M D, Macmillan B, Pappin A J, Roling B and Hutchinson J M 1998 *Solid State Ion.* **105** 103
- [25] Martin S W 1986 *Solid State Ion.* **18/19** 472
- [26] Funke K, Banhatti R D, Brueckner S, Cramer C, Krieger C, Mandanici A, Martiny C and Ross I 2002 *Phys. Chem. Chem. Phys.* **4** 3155
- [27] Kamitsos E I, Patsis A P and Chryssikos G D 1991 *Phys. Chem. Glasses* **32** 219
- [28] Ratai E, Chan J C C and Eckert E 2002 *Phys. Chem. Chem. Phys.* **4** 3198
- [29] Shelby J E and Day D E 1969 *J. Am. Ceram. Soc.* **52** 169
- [30] Roling B and Ingram M D 1998 *Phys. Rev. B* **57** 14192
- [31] Roling B and Ingram M D 1998 *Solid State Ion.* **105** 47
- [32] Conway B E and Barradas R G 1966 *Chemical Physics of Ionic Conductors* (New York: Wiley)
- [33] Moynihan C T, Saad N S, Tran D C and Lesikar A V 1980 *J. Am. Ceram. Soc.* **63** 458
- [34] Moynihan C T and Lesikar A V 1981 *J. Am. Ceram. Soc.* **64** 40
- [35] Bruce J A, Ingram M D, Mackenzie M A and Syed R 1986 *Solid State Ion.* **18/19** 410
- [36] Ingram M D, Mackenzie M A, Müller W and Torge M 1990 *Solid State Ion.* **40/41** 671
- [37] Baucke F G K and Werner R D 1989 *Glastech. Ber.—Glass Sci. Technol.* **62** 182
- [38] Ingram M D, Davidson J E, Coats A M, Kamitsos E I and Kapoutsis J A 2000 *Glastech. Ber.—Glass Sci. Technol.* **73** 89
- [39] Bradshaw J M and Taylor B 1992 *The Physics of Non-Crystalline Solids* ed L D Pye, W C LaCourse and H J Stevens (London: Taylor and Francis)
- [40] Tomandl G and Schaeffer H A 1977 *Physics of Non-Crystalline Solids* ed G H Frischat (Aedermannsdorf: Trans. Tech.)
- [41] Roling B and Ingram M D 2000 *J. Non-Cryst. Solids* **265** 113
- [42] Martiny C, Murugavel S, Roling B, Natrup F, Bracht H and Ingram M D 2002 *Glass Technol.* at press
- [43] Tsang K Y and Ngai K L 1997 *Phys. Rev. E* **56** 17R
- [44] Howell F S, Bose R A, Macedo P B and Macedo C T 1974 *J. Phys. Chem.* **78** 639
- [45] Angell C A 1986 *Solid State Ion.* **18/19** 72